

Rheolau Sin a Cos

The Sine and Cosine Rules

Y Llyfr Adolygu

The Revision Book

- 1 Cyfrifwch hyd CB i un lle degol
Calculate the length of CB to one decimal place

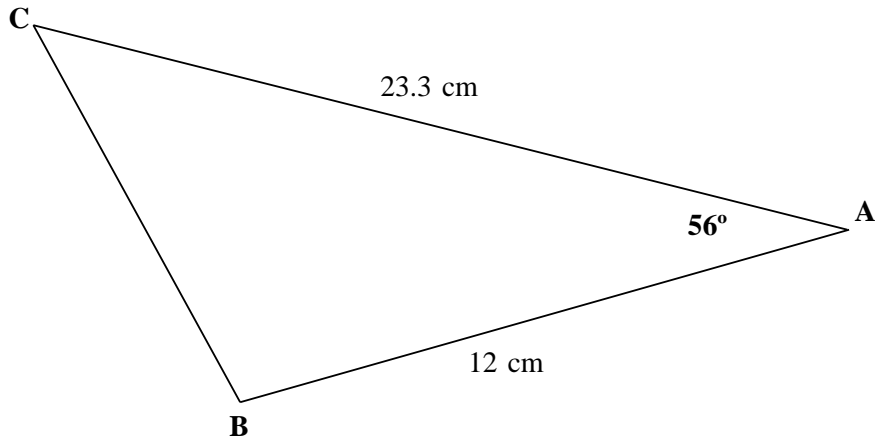

- 2 Cyfrifwch hyd CB i un lle degol
Calculate the length of CB to one decimal place

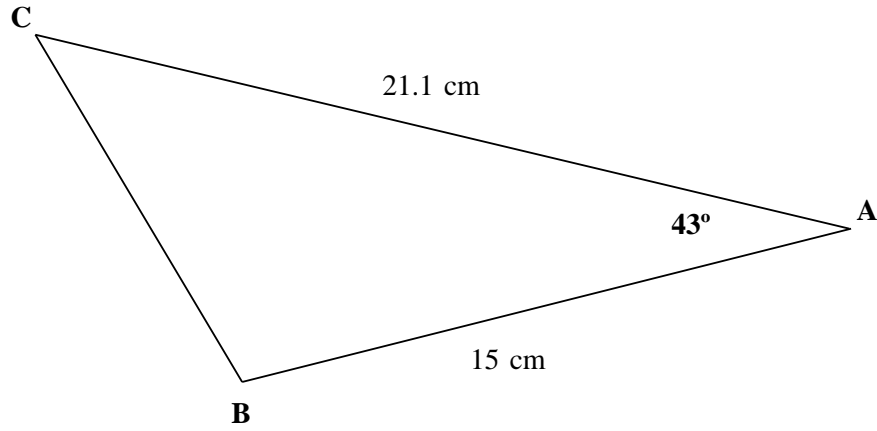

3 Cyfrifwch $\hat{A}CB$ i'r radd agosaf
Calculate $\hat{A}CB$ to the nearest degree

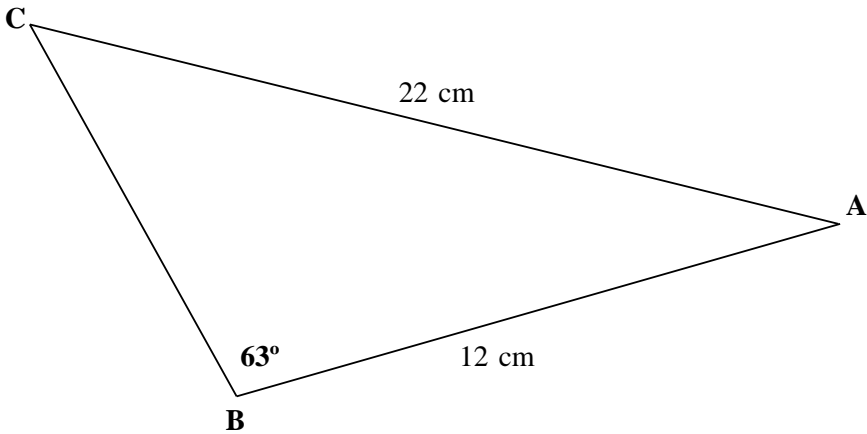

4 Cyfrifwch hyd CA i un lle degol
Calculate the length CA to one decimal place

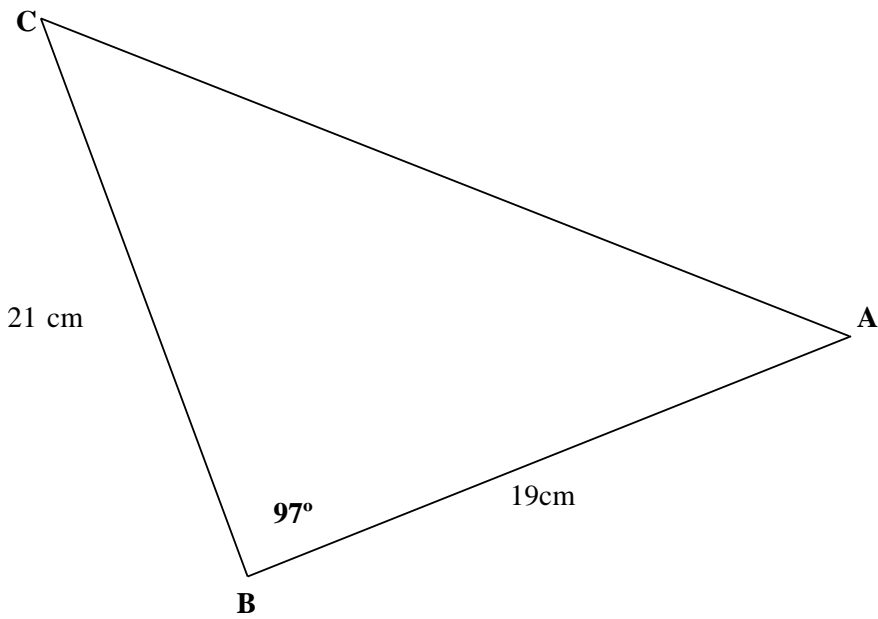

5 Cyfrifwch $\hat{A}CB$ i'r radd agosaf
Calculate $\hat{A}CB$ to the nearest degree

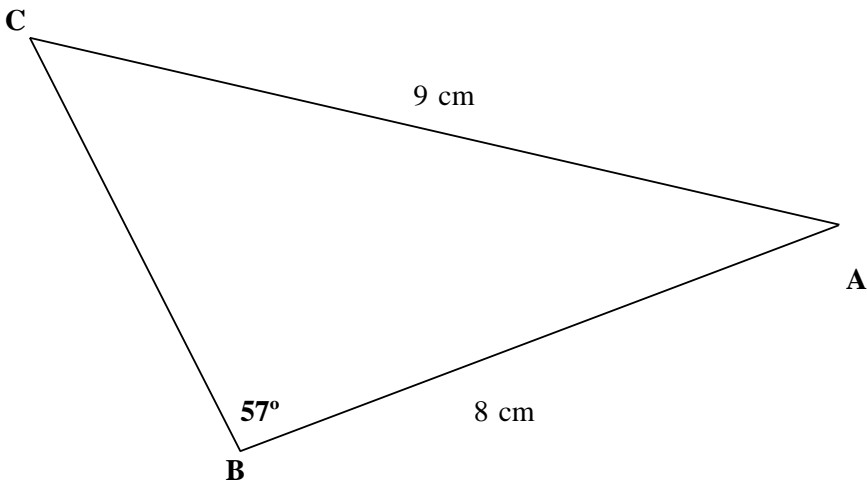

- 6 Cyfrifwch $\hat{A}CB$ i'r radd agosaf
Calculate $\hat{A}CB$ to the nearest degree

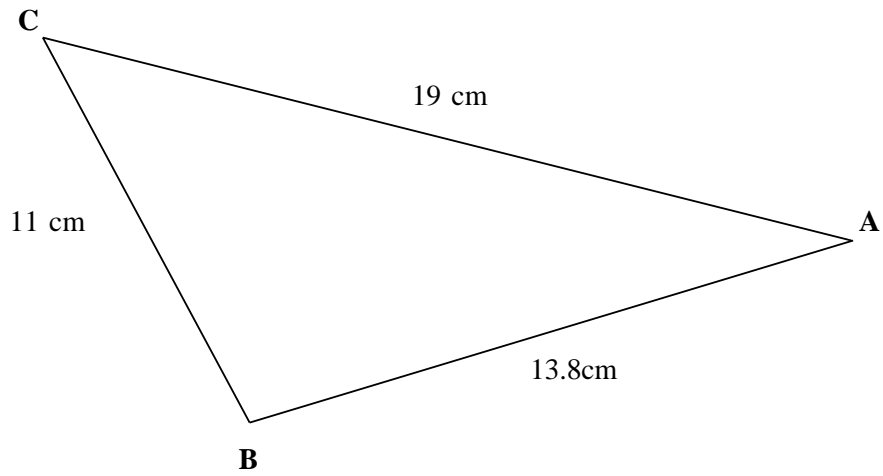

- 7 Cyfrifwch hyd CB i un lle degol
Calculate the length of CB to one decimal place

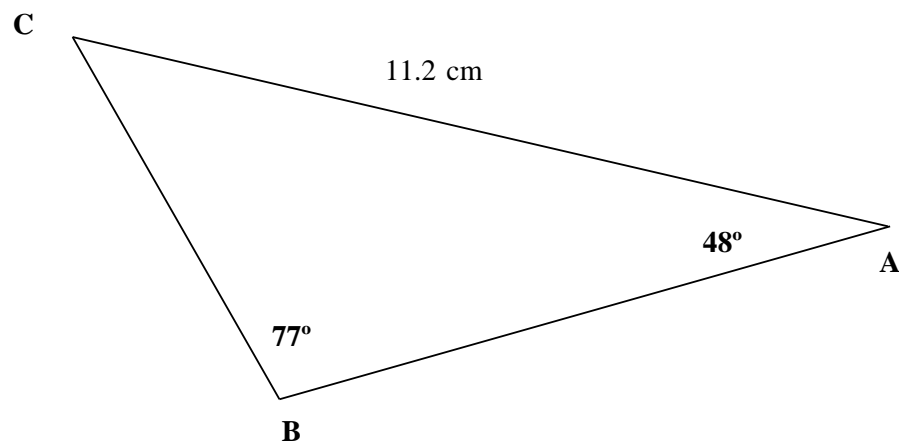

- 8 Cyfrifwch $\hat{D}EF$ i'r radd agosaf
Calculate $\hat{D}EF$ to the nearest degree

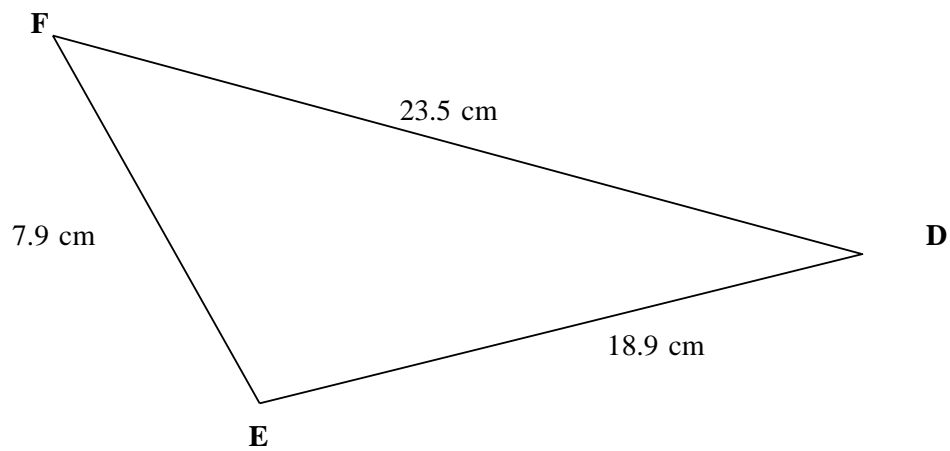

- 9 Cyfrifwch $\hat{A}CB$ i'r radd agosaf
Calculate $\hat{A}CB$ to the nearest degree

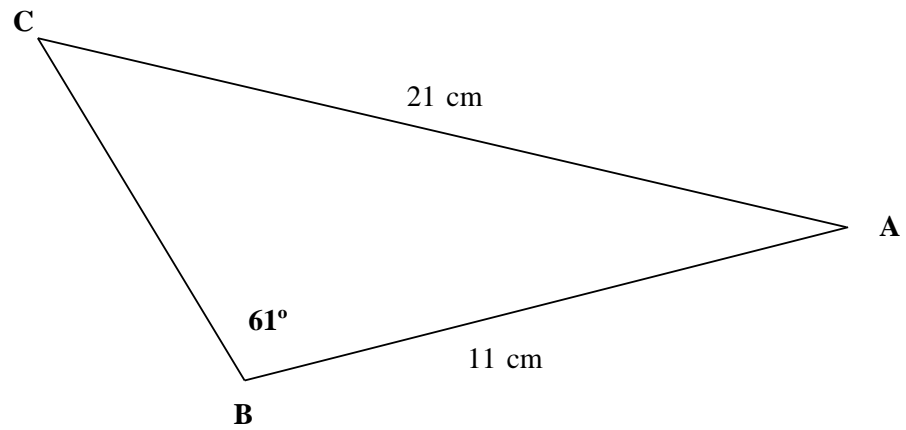

- 10 Cyfrifwch $\hat{D}EF$ i'r radd agosaf
Calculate $\hat{D}EF$ to the nearest degree

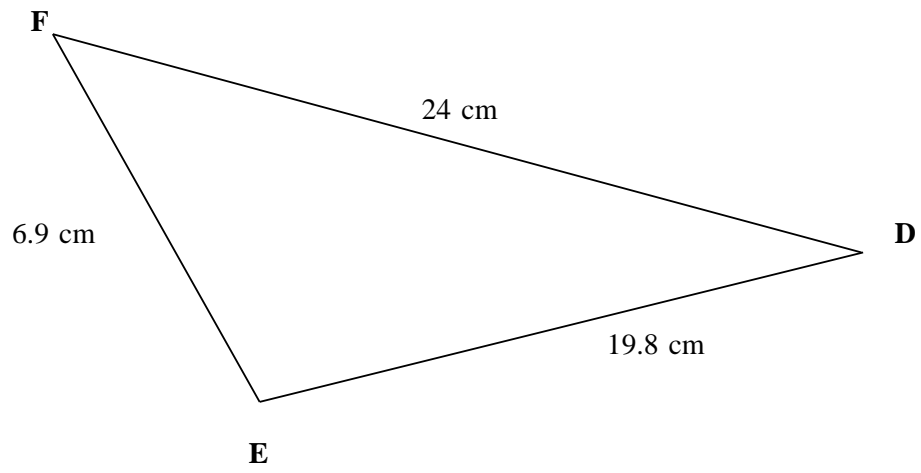

- 11 Cyfrifwch ABC i'r radd agosaf
Calculate ABC to the nearest degree

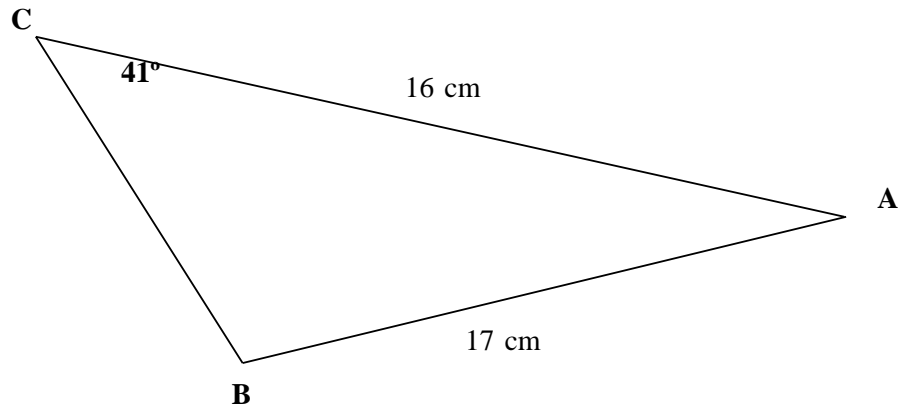

- 12 Cyfrifwch $\hat{D}EF$ i'r radd agosaf
Calculate $\hat{D}EF$ to the nearest degree

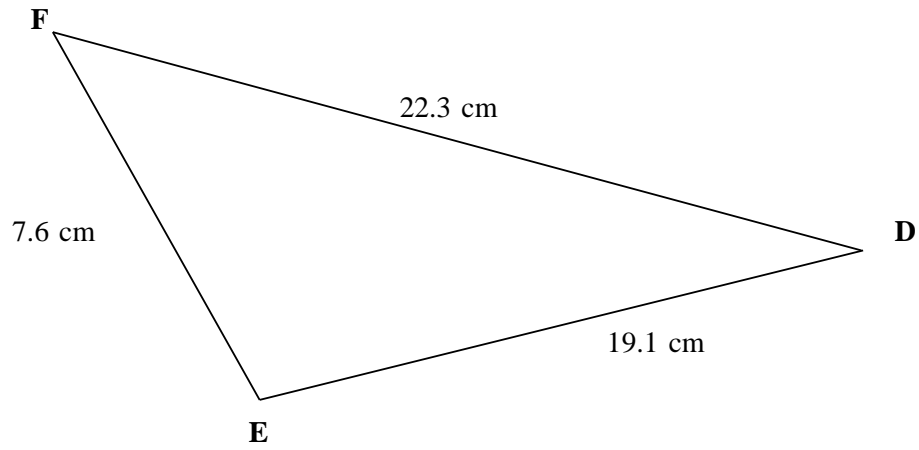

- 13 Cyfrifwch hyd CA i un lle degol
Calculate the length CA to one decimal place

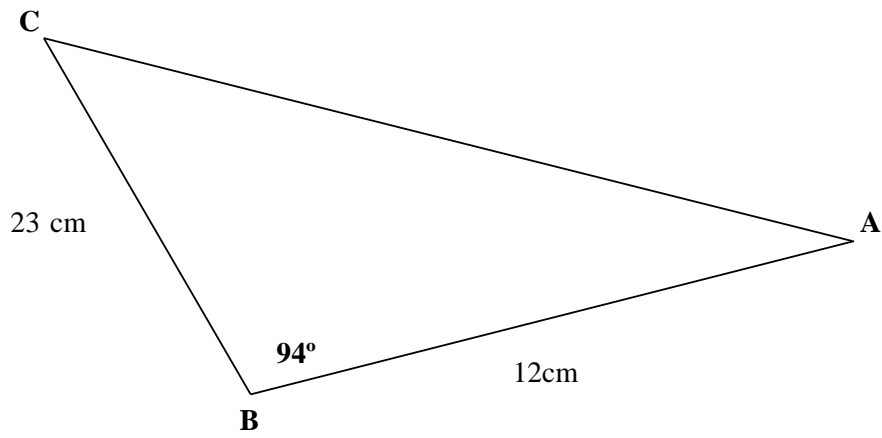

- 14 Cyfrifwch $\hat{A}CB$ i'r radd agosaf
Calculate $\hat{A}CB$ to the nearest degree

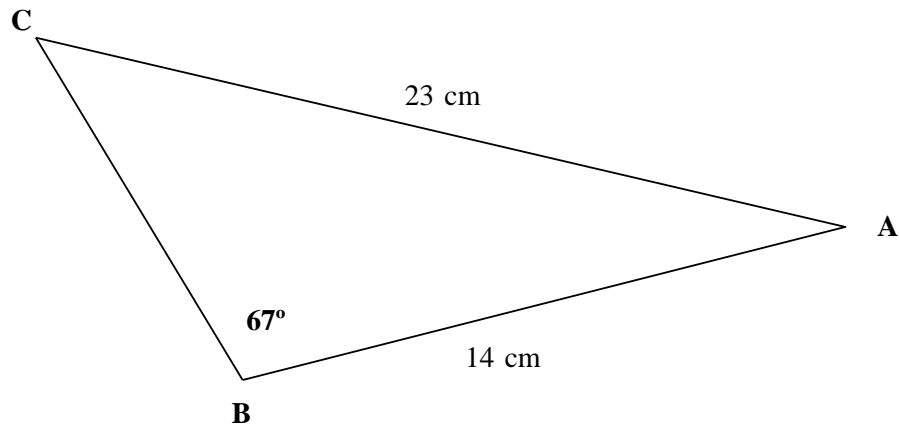

- 15 Cyfrifwch hyd CA i un lle degol
Calculate the length CA to one decimal place

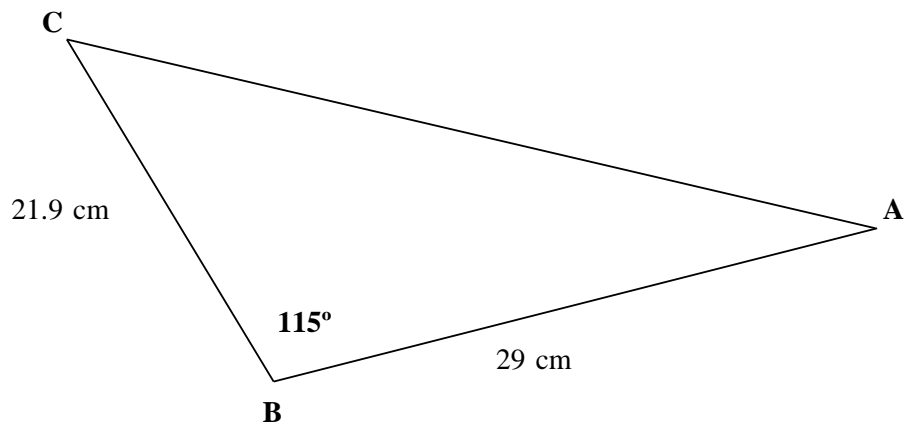

- 16 Cyfrifwch hyd AB i un lle degol
Calculate the length of AB to one decimal place

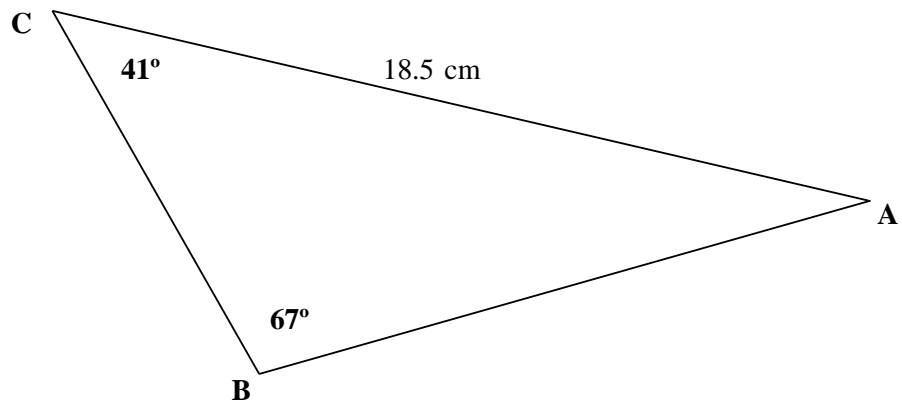

- 17 Cyfrifwch $\hat{A}CB$ i'r radd agosaf
Calculate $\hat{A}CB$ to the nearest degree

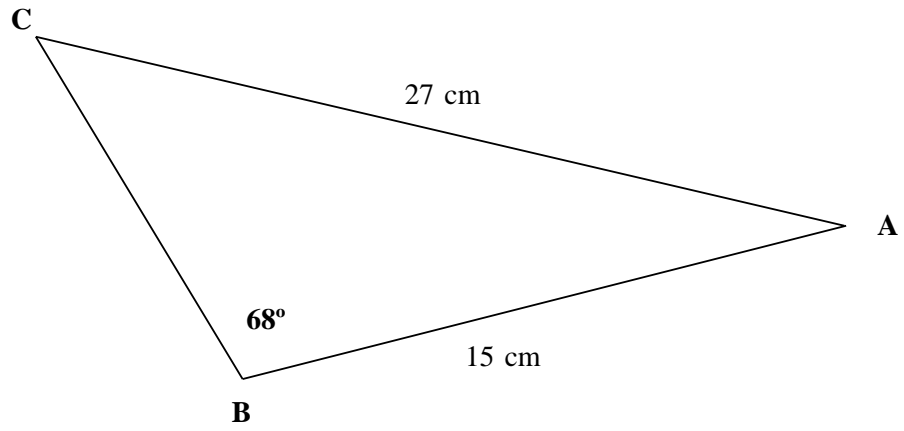

18 Cyfrifwch $\hat{D}EF$ i'r radd agosaf
Calculate $\hat{D}EF$ to the nearest degree

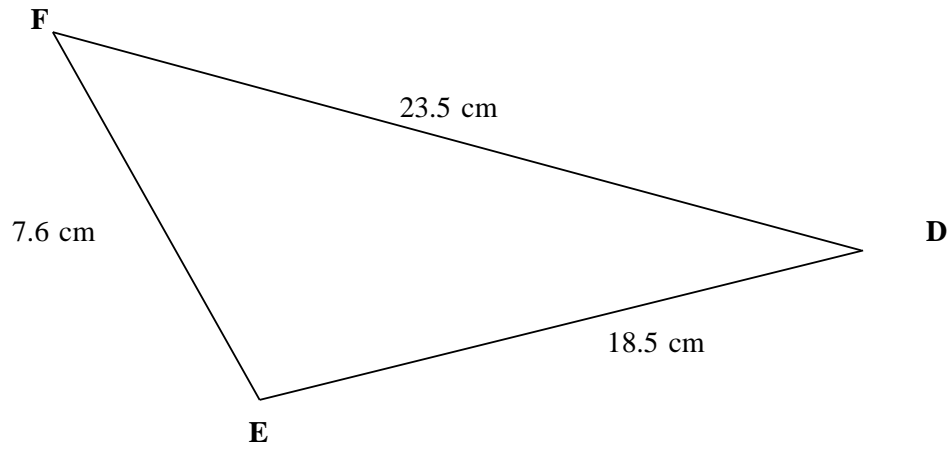

- 19 Cyfrifwch $\hat{A}CB$ i'r radd agosaf
Calculate $\hat{A}CB$ to the nearest degree

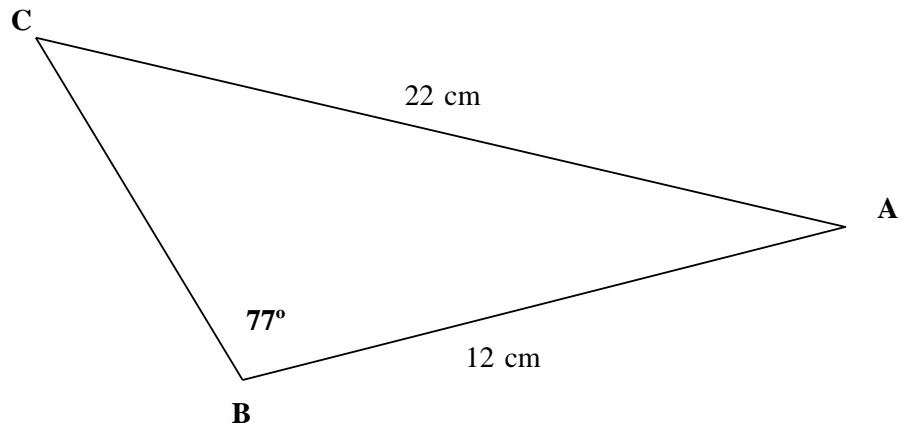

20 Cyfrifwch $\hat{D}EF$ i'r radd agosaf
Calculate $\hat{D}EF$ to the nearest degree

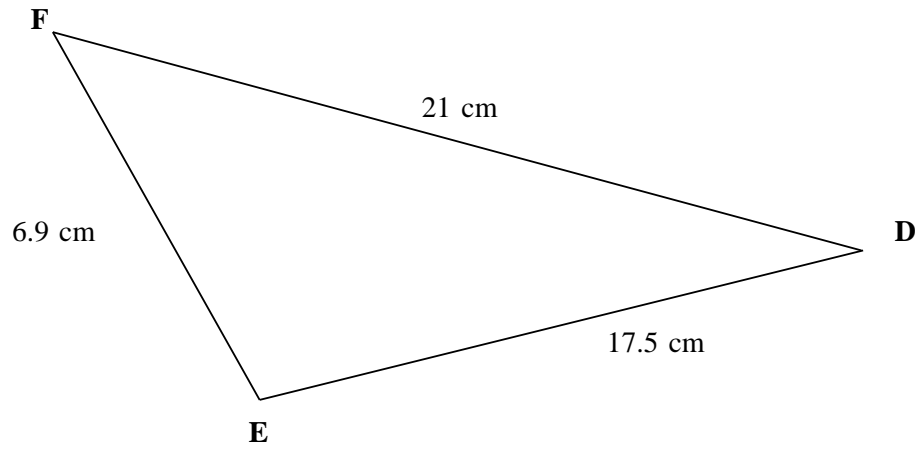

- 21** Cyfrifwch hyd CB i un lle degol
Calculate the length of CB to one decimal place

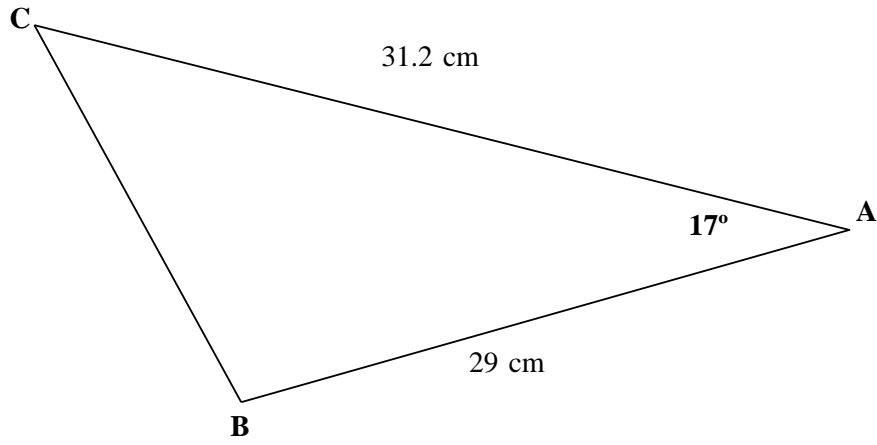

- 22 Cyfrifwch hyd CB i un lle degol
Calculate the length of CB to one decimal place

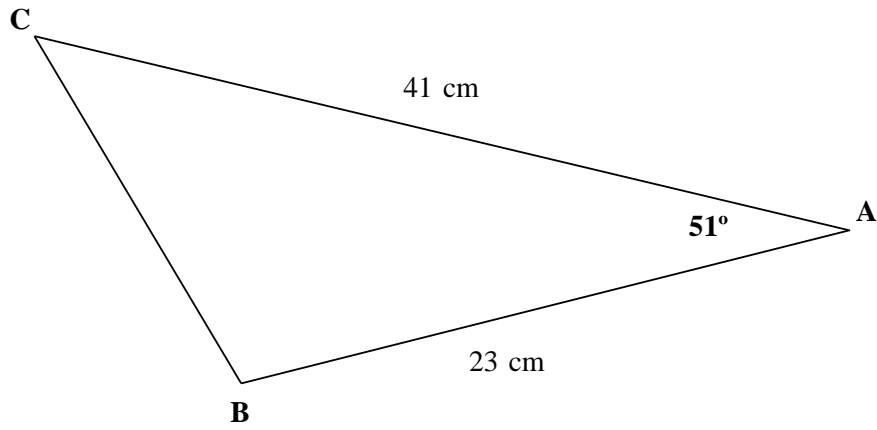

- 23 Cyfrifwch hyd CB i un lle degol
Calculate the length of CB to one decimal place

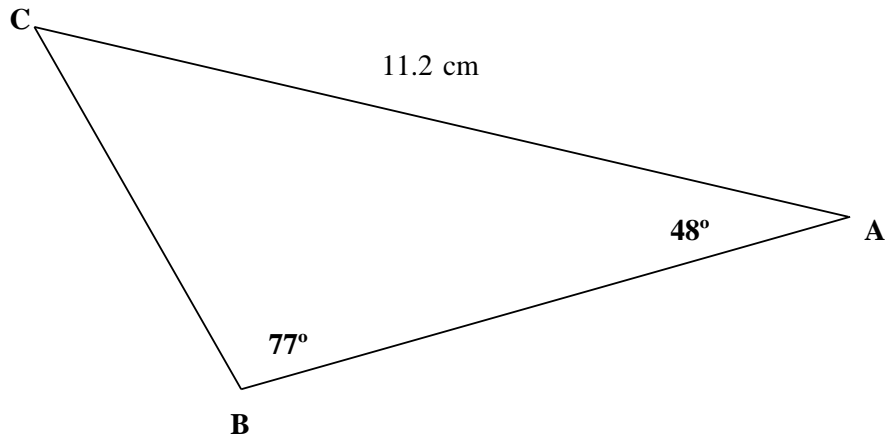

- 24 Cyfrifwch hyd CB i un lle degol
Calculate the length of CB to one decimal place

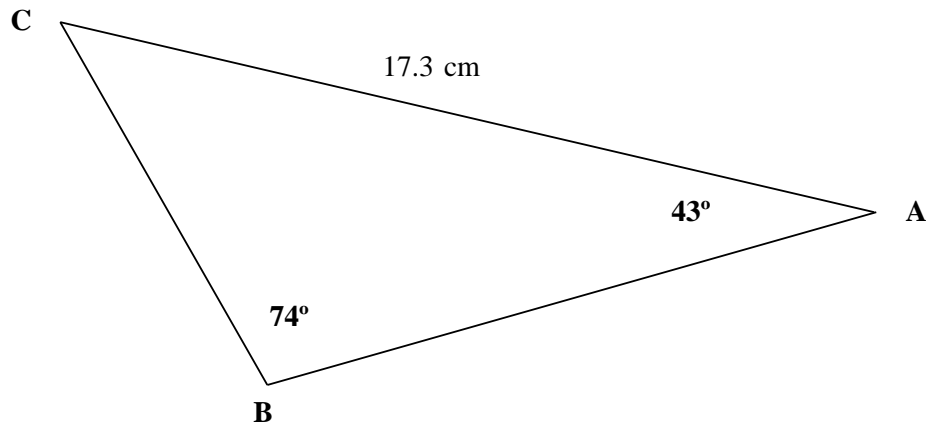

Atebion/Answers

- 1** 19.3cm
- 2** 14.4cm
- 3** 29°
- 4** 30cm
- 5** 48°
- 6** 46°
- 7** 8.5cm
- 8** 116°
- 9** 27°
- 10** 120°
- 11** 38°
- 12** 105°
- 13** 26.7cm
- 14** 34°
- 15** 43.1cm
- 16** 13.2cm
- 17** 31°
- 18** 123°
- 19** 32°
- 20** 111°
- 21** 9.2cm
- 22** 32cm
- 23** 8.5cm
- 24** 12.3cm